

**160V 3-Phase Bridge Driver**
**PRODUCT SUMMARY**

- $V_{\text{OFFSET}}$  160 V max.
- $I_{\text{O+/-}}$  350 mA / 650 mA
- $V_{\text{OUT}}$  10 V - 20 V
- $t_{\text{on/off (typ.)}}$  130 ns / 150 ns
- **Deadtime (typ.)** 270 ns

**FEATURES**

- Floating channel designed for bootstrap operation
- Fully operational to +160 V
- Tolerant to negative transient voltage,  $dV/dt$  immune
- Gate drive supply range from 10 V to 20 V
- Undervoltage lockout for all channels
- 3.3 V, 5 V, and 15 V logic compatible
- Lower  $di/dt$  gate drive for better noise immunity
- Cross-conduction prevention logic with Typ. 270ns dead time
- Available in SOIC-20L (WB) and TSSOP-20L (NB) packages

**GENERAL DESCRIPTION**

The SLM7888 is a high voltage, high speed power MOSFET and IGBT drivers with three independent high- and low-side referenced output channels for 3-phase applications.

Proprietary HVIC and latch immune CMOS technologies enable ruggedized monolithic construction.

The logic inputs are compatible with standard CMOS or LSTTL output, down to 3.3 V logic.

An advanced level-shift circuit allows high-side gate driver operation up to  $V_S = -9.8V$  for  $V_{BS} = 15V$ .

The UVLO circuits prevent malfunction when VDD and VBS are lower than the specified threshold voltage.

Propagation delays are matched to simplify use in high frequency applications.

The floating channel can be used to drive an N-channel power MOSFET or IGBT in the high-side configuration which operates up to 160 V.

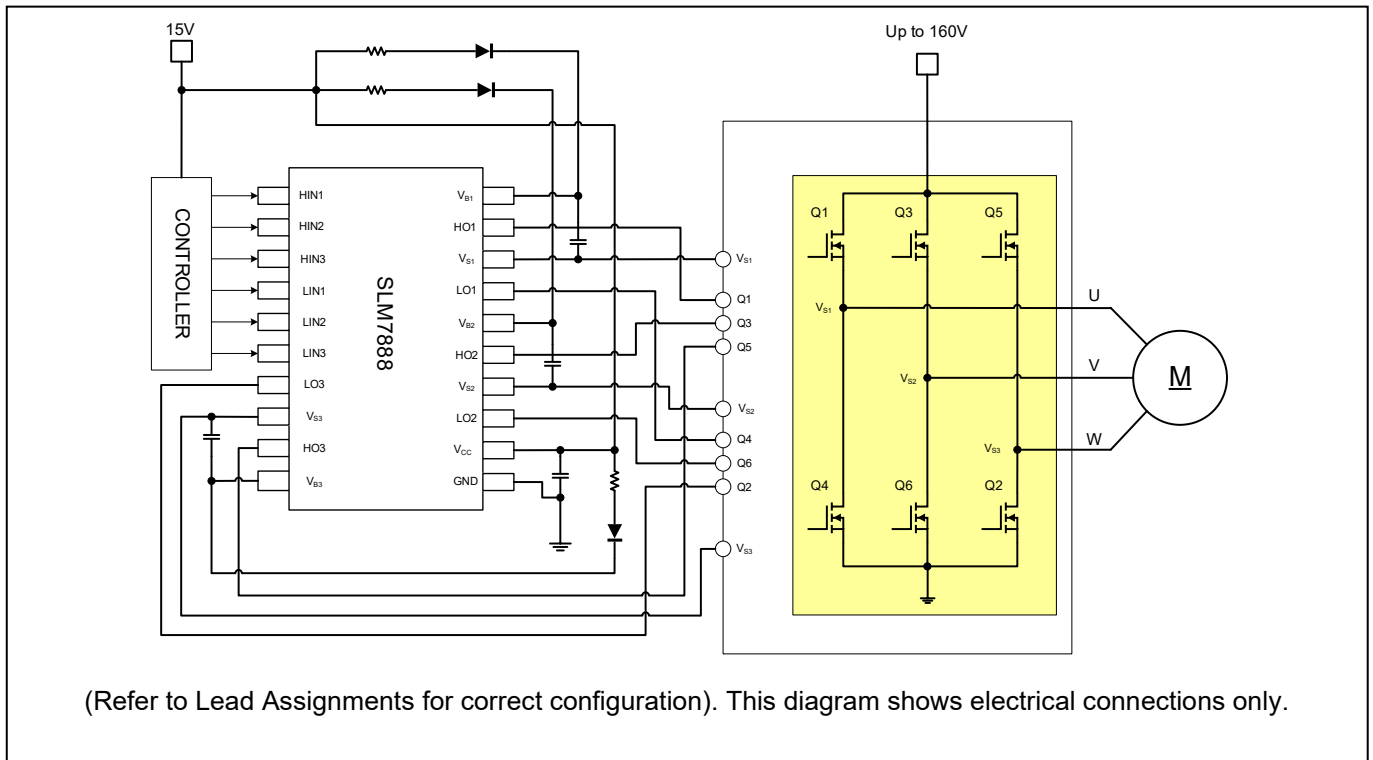
**TYPICAL APPLICATION CIRCUIT**

**Figure 1 Typical Application Circuit**

**PIN CONFIGURATION**

Package	Pin Configuration (Top View)			
SOIC-20L (WB) TSSOP-20L (NB)	1	HIN1	$V_{B1}$	20
	2	LIN1	HO1	19
	3	HIN2	$V_{S1}$	18
	4	LIN2	LO1	17
	5	HIN3	$V_{B2}$	16
	6	LIN3	HO2	15
	7	LO3	$V_{S2}$	14
	8	$V_{S3}$	LO2	13
	9	HO3	$V_{DD}$	12
	10	$V_{B3}$	GND	11

**Figure 2 Pin Configuration**

**PIN DESCRIPTION**

No.	Pin	Description
1, 3, 5	HIN1, 2, 3	Logic input for high-side gate driver output (HO).
2, 4, 6	LIN1, 2, 3	Logic input for low-side gate driver output (LO).
19, 15, 9	HO1, 2, 3	High-side gate driver outputs.
17, 13, 7	LO1, 2, 3	Low-side gate driver outputs.
18, 14, 8	$V_{S1, 2, 3}$	High-side drivers floating supply offset.
20, 16, 10	$V_{B1, 2, 3}$	High-side drivers floating supply.
11	GND	Ground.
12	$V_{DD}$	Logic and all low-side gate drivers power supply.

**ORDERING INFORMATION**
**Industrial Range: -40°C to +125°C**

Order Part No.	Package	QTY
SLM7888CH	SOIC-20L (WB), Pb-Free	1000/Reel
SLM7888MD	TSSOP-20L (NB), Pb-Free	4000/Reel

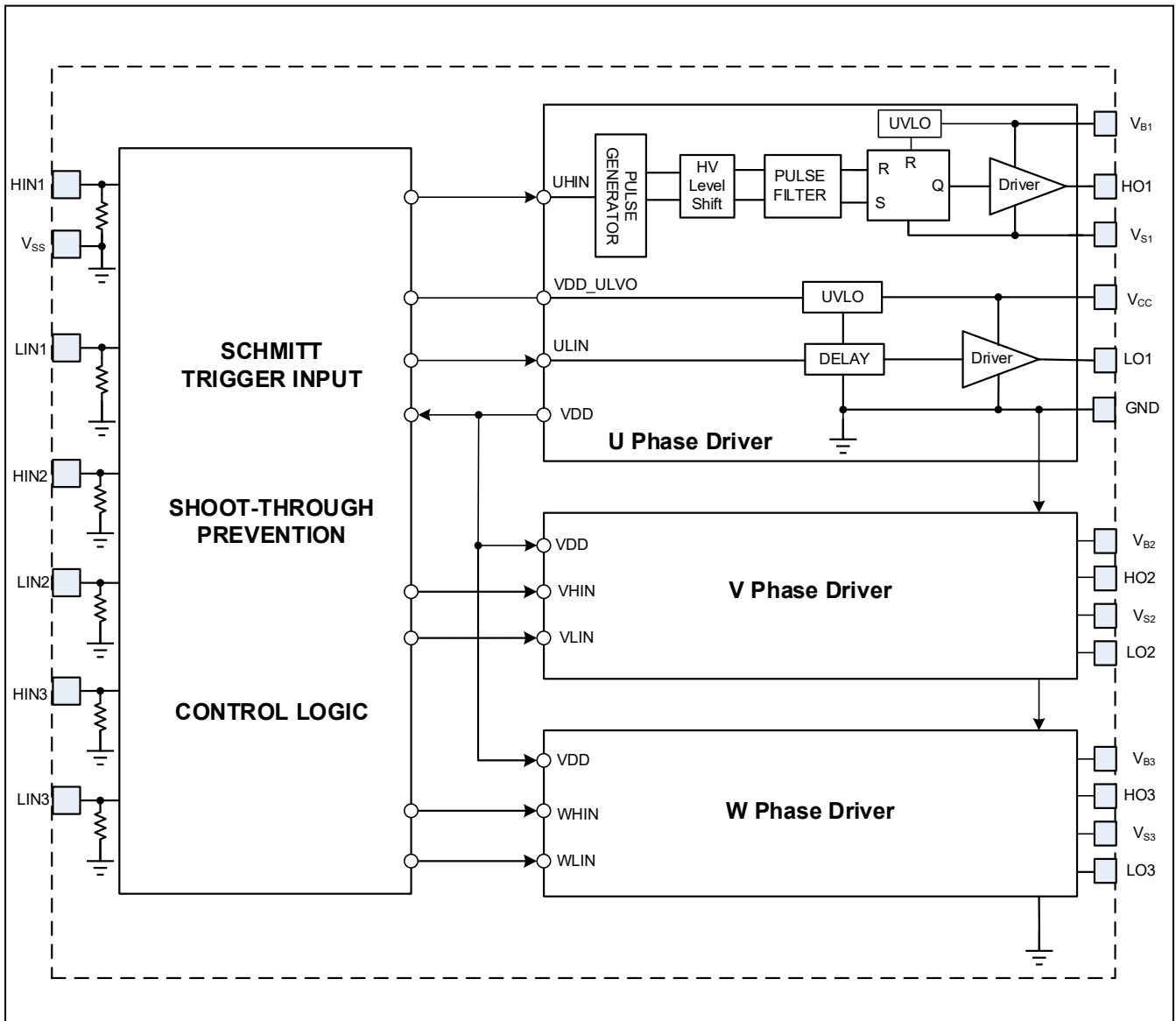
**FUNCTIONAL BLOCK DIAGRAM**

**Figure 3 Functional Block Diagram**

**ABSOLUTE MAXIMUM RATINGS**

Symbol	Definition	Min.	Max.	Units	
V <sub>B</sub>	High-side floating absolute voltage	-0.3	185	V	
V <sub>S</sub>	High-side floating supply offset voltage	V <sub>B1,2,3</sub> - 25	V <sub>B1,2,3</sub> + 0.3		
V <sub>HO</sub>	High-side floating output voltage	V <sub>S1,2,3</sub> - 0.3	V <sub>B1,2,3</sub> + 0.3		
V <sub>CC</sub>	Low-side and logic fixed supply voltage	-0.3	25		
V <sub>IN</sub>	Logic input voltage (LIN, HIN)	- 0.3	V <sub>DD</sub> + 0.3		
V <sub>LO1,2,3</sub>	Low-side output voltage	-0.3	V <sub>DD</sub> + 0.3		
dV <sub>S</sub> /dt	Allowable offset supply voltage transient	---	50	V/ns	
P <sub>D</sub>	Package power dissipation @ T <sub>A</sub> ≤ +25°C	SOIC-20L (WB)	---	1.5	W
		TSSOP-20L (NB)	---	1.2	
R <sub>thJA</sub>	Thermal resistance, junction to ambient	SOIC-20L (WB)	---	60	°C/W
		TSSOP-20L (NB)	---	75	
T <sub>J</sub>	Junction temperature	-40	125	°C	
T <sub>S</sub>	Storage temperature	-55	150		
T <sub>L</sub>	Lead temperature (soldering, 10 seconds)	---	300		

**Note:**

Absolute maximum ratings indicate sustained limits beyond which damage to the device may occur. All voltage parameters are absolute voltages referenced to GND. The thermal resistance and power dissipation ratings are measured under board mounted and still air conditions.

**RECOMMENDED OPERATING CONDITIONS**

Symbol	Definition	Min.	Max.	Units
V <sub>B1,2,3</sub>	High-side floating supply voltage	V <sub>S1,2,3</sub> + 10	V <sub>S1,2,3</sub> + 20	V
V <sub>S1,2,3</sub>	High-side floating supply offset voltage	- 0.3	160	
V <sub>HO1,2,3</sub>	High-side floating output voltage	V <sub>S1,2,3</sub>	V <sub>B1,2,3</sub>	
V <sub>LO1,2,3</sub>	Low-side output voltage	GND	V <sub>DD</sub>	
V <sub>DD</sub>	Low-side and logic fixed supply voltage	10	20	
V <sub>IN</sub>	Logic input voltage (LIN, HIN)	GND	V <sub>DD</sub>	
T <sub>A</sub>	Ambient temperature	- 40	125	°C

**DYNAMIC ELECTRICAL CHARACTERISTICS**
 $V_{BIAS} (V_{DD}, V_{BS}) = 15\text{ V}$ ,  $V_{S1,2,3} = \text{GND}$ ,  $C_L = 1000\text{ pF}$  and  $T_A = 25^\circ\text{C}$  unless otherwise specified.

Symbol	Parameter	Condition	Min.	Typ.	Max.	Unit
$t_{on}$	Turn-on propagation delay	$V_S = 0\text{ V}$	---	130	220	ns
$t_{off}$	Turn-off propagation delay	$V_S = 160\text{ V}$	---	150	240	
$t_r$	Turn-on rise time		---	50	120	
$t_f$	Turn-off fall time		---	30	80	
DT	Deadtime, LS turn-off to HS turn-on & HS turn-on to LS turn-off	$V_{IN} = 0\text{ V} \& 5\text{ V}$	100	270	440	
MT	Matching delay, HS & LS turn-on/off	External dead time > 400 ns	---	40	60	
MDT	Matching delay, max ( $t_{on}$ , $t_{off}$ ) – min ( $t_{on}$ , $t_{off}$ ), ( $t_{on}$ , $t_{off}$ are applicable to all 3 channels)		---	25	50	

**STATIC ELECTRICAL CHARACTERISTICS**
 $V_{BIAS} (V_{DD}, V_{BS1,2,3}) = 15\text{ V}$  and  $T_A = 25^\circ\text{C}$  unless otherwise specified. The  $V_{IN}$ ,  $V_{TH}$ , and  $I_{IN}$  parameters are referenced to GND and are applicable to all 6 channels (LIN, HIN). The  $V_O$  and  $I_O$  parameters are referenced to GND and  $V_{S1,2,3}$  and are applicable to the respective output leads: HO1,2,3 and LO1,2,3.

Symbol	Parameter	Condition	Min.	Typ.	Max.	Unit
$V_{IH}$	Logic "0" input voltage (LIN, HIN)	$V_{CC} = 10\text{ V to }20\text{ V}$	2.5	---	---	V
$V_{IL}$	Logic "1" input voltage (LIN, HIN)		---	---	1.0	
$V_{OH}$	High level output voltage, $V_{BIAS} - V_O$	$I_O = 20\text{ mA}$	---	0.5	1.0	
$V_{OL}$	Low level output voltage, $V_O$		---	0.3	0.6	
$V_S$	Available negative $V_S$ pin voltage for input signal propagation to Ho		---	- 9.8	- 7.0	
$V_{DDUV+}$ $V_{BSUV+}$	$V_{DD}$ and $V_{BS}$ supply undervoltage positive going threshold		6.0	6.7	7.8	
$V_{DDUV-}$ $V_{BSUV-}$	$V_{DD}$ and $V_{BS}$ supply undervoltage negative going threshold		5.4	6.2	7.0	
$V_{DDUVH}$ $V_{BSUVH}$	$V_{DD}$ and $V_{BS}$ supply undervoltage lockout hysteresis		0.3	0.5	---	
$I_{LK}$	Offset supply leakage current	$V_{B1,2,3} = V_{S1,2,3} = 160\text{ V}$	---	---	10	$\mu\text{A}$
$I_{QBS}$	Quiescent $V_{BS}$ supply current	$V_{IN} = 0\text{ V or }5\text{ V}$	---	65	120	
$I_{QDD}$	Quiescent $V_{DD}$ supply current		---	300	500	
$I_{OPDD}$	Operating $V_{DD}$ supply current for each channel		$f_{LIN1,2,3} = 20\text{ kHz, rms Value}$	---	500	
$I_{OPBS}$	Operating $V_{BS}$ supply current for each channel	$f_{LIN1,2,3} = 20\text{ kHz, rms Value}$	---	400	800	
$I_{IN+}$	Logic "1" input bias current	HIN1, 2, 3 = 5 V, LIN1, 2, 3 = 5 V	---	25	50	$\mu\text{A}$
$I_{IN-}$	Logic "0" input bias current	HIN1, 2, 3 = 0 V, LIN1, 2, 3 = 0 V	---	---	2	
$I_{O+}$	Output high short circuit pulsed current	$V_O = 0\text{ V}$ , $V_{IN} = V_{IH}$ $PW \leq 10\text{ }\mu\text{s}$	---	350	---	mA
$I_{O-}$	Output low short circuit pulsed current	$V_O = 15\text{ V}$ , $V_{IN} = V_{IL}$ $PW \leq 10\text{ }\mu\text{s}$	---	650	---	
$R_{IN}$	Input pull-down resistance		150	200	20	k $\Omega$

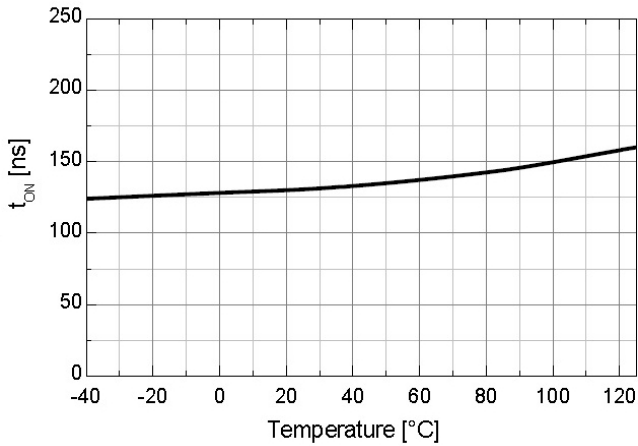
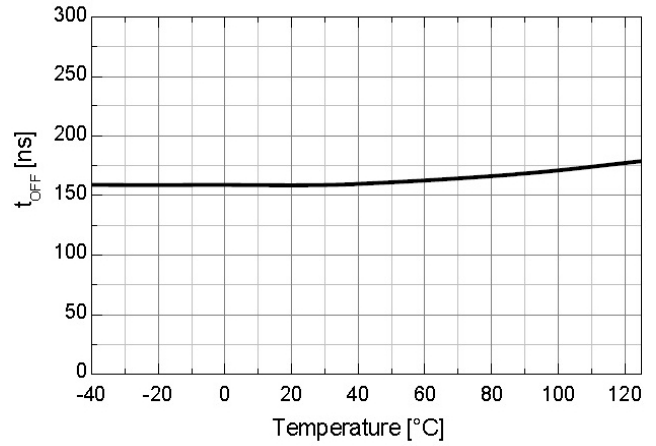
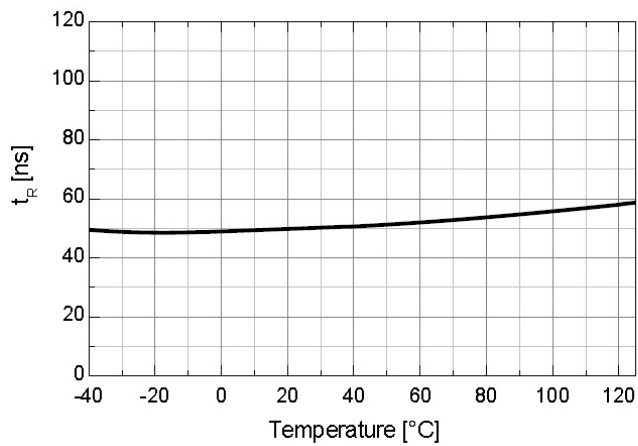
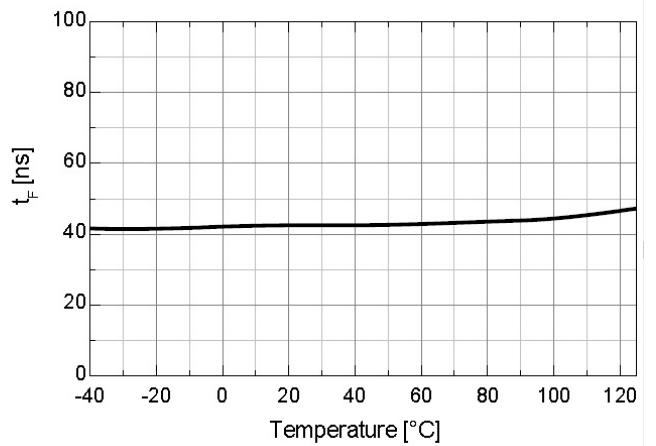
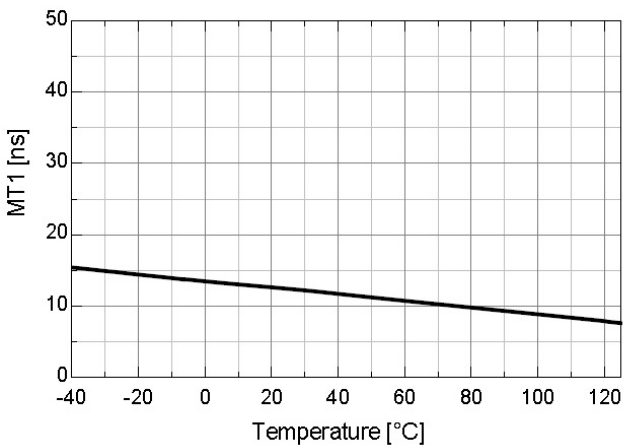
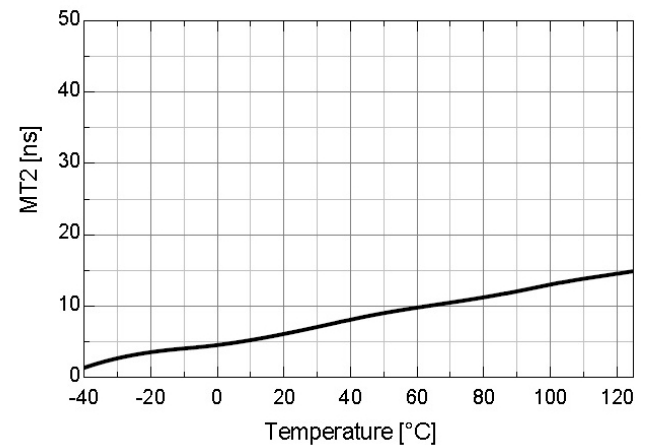
**TYPICAL CHARACTERISTICS**

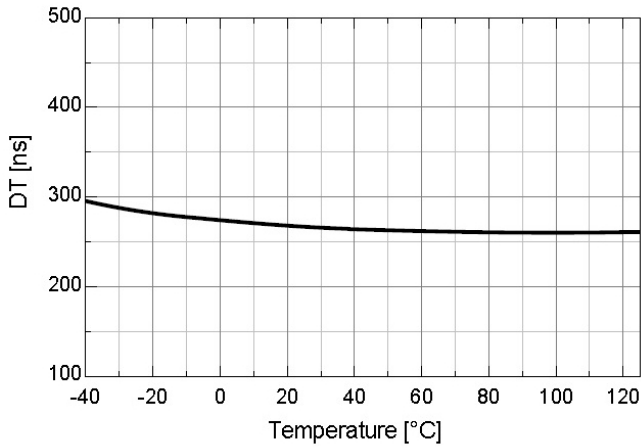
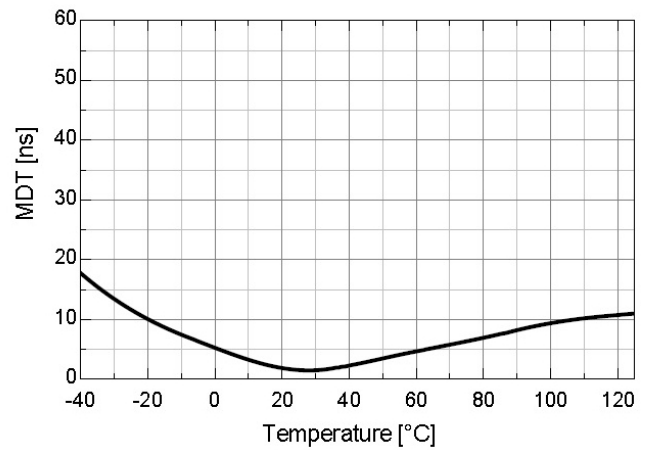
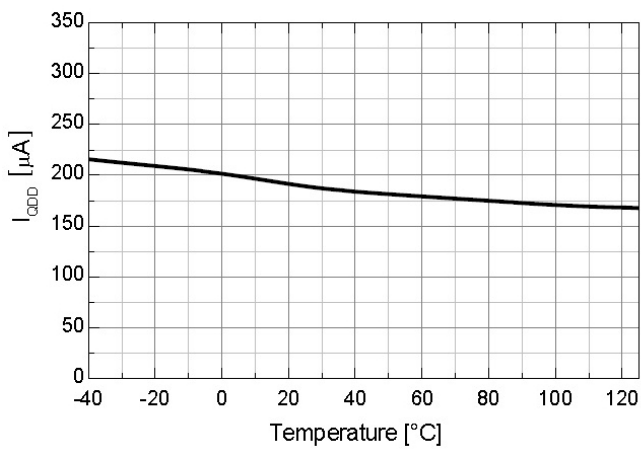
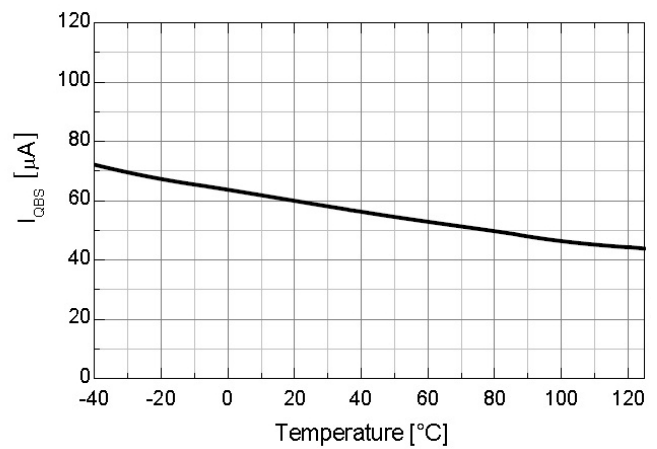
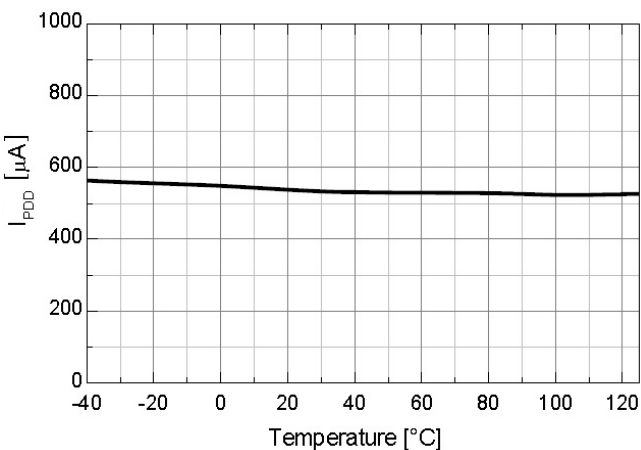
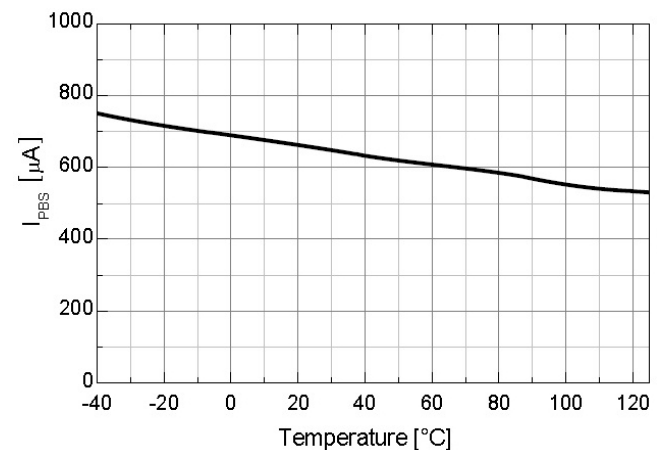
**Figure 4 Turn-on Propagation Delay vs. Temp.**

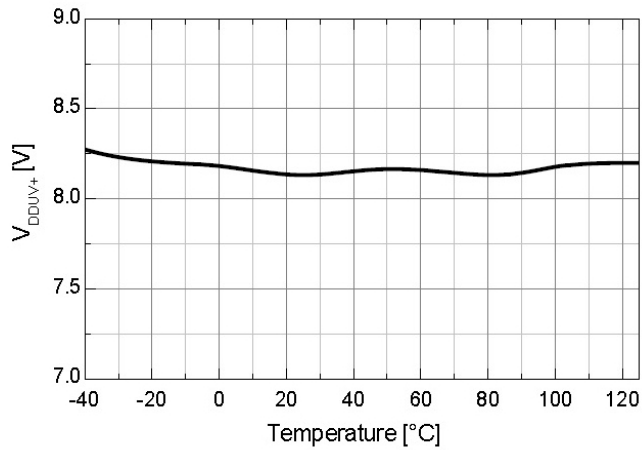
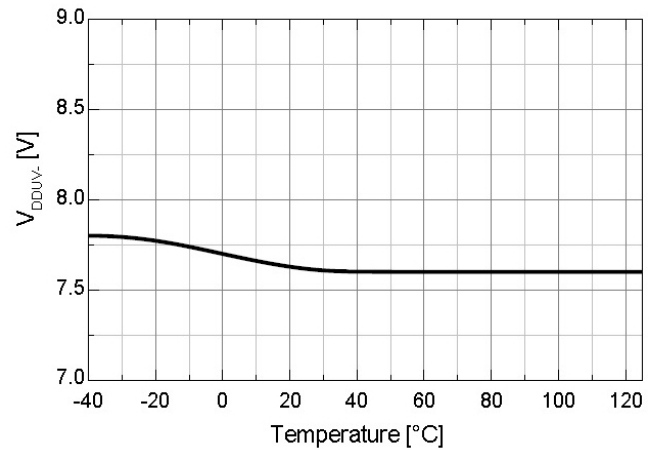
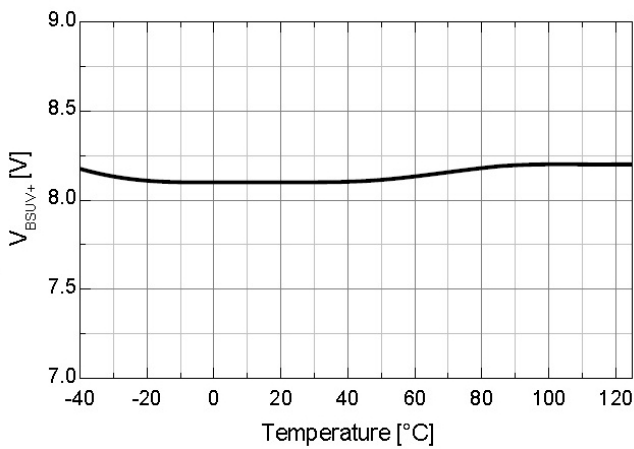
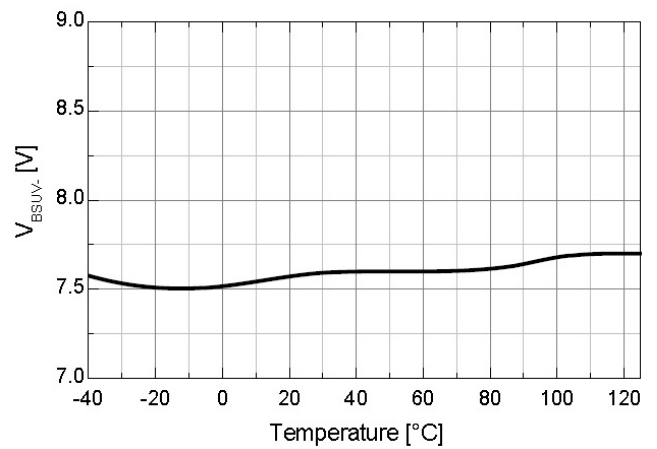
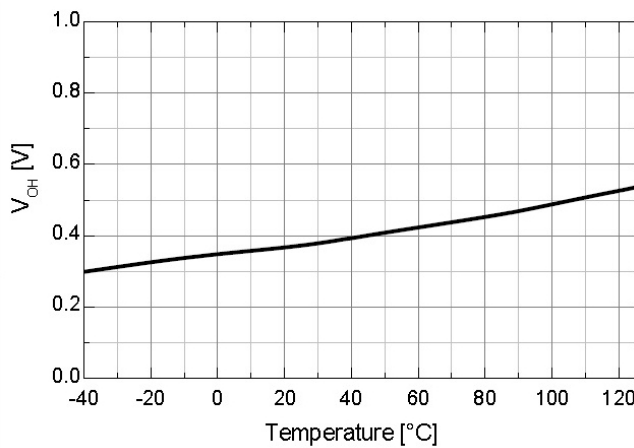
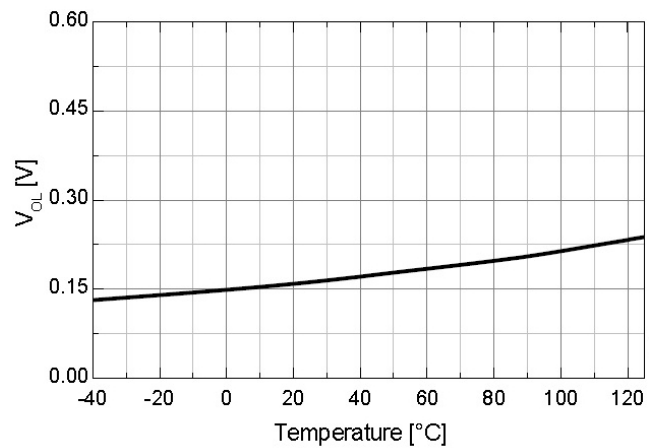
**Figure 5 Turn-off Propagation Delay vs. Temp.**

**Figure 6 Turn-on Rise Time vs. Temp.**

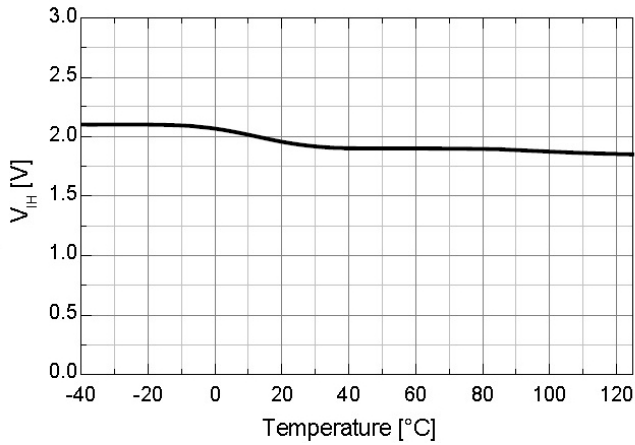
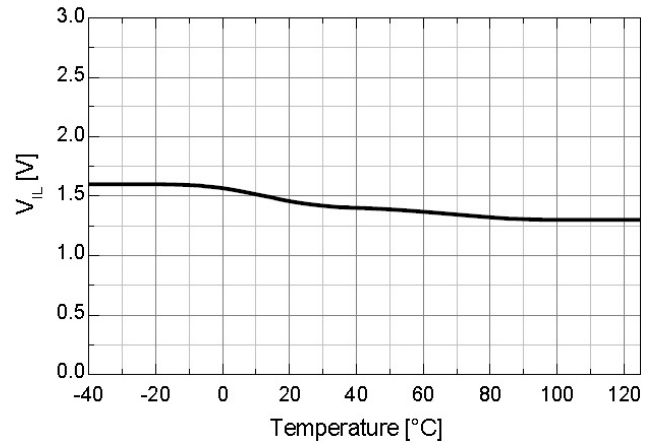
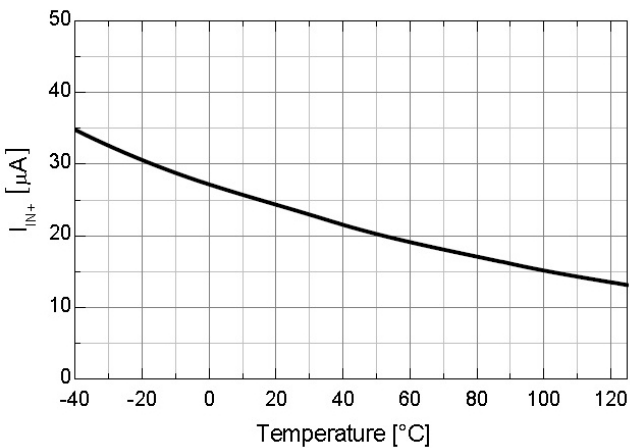
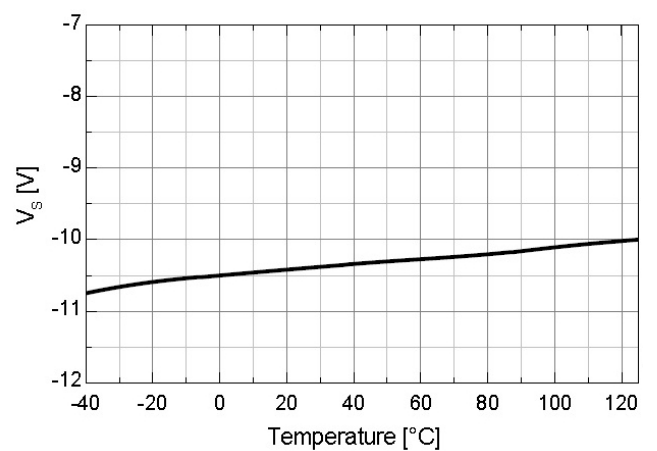
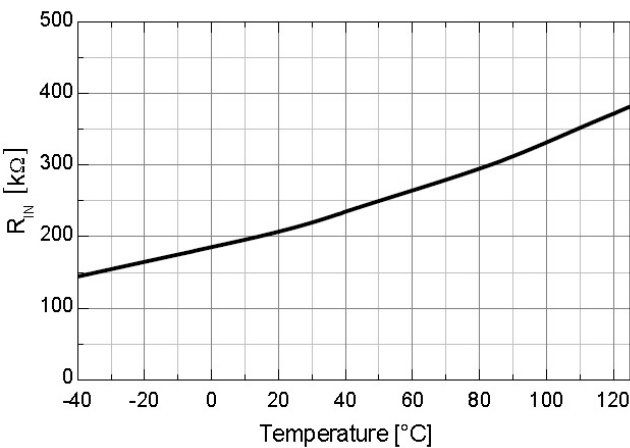
**Figure 7 Turn-off Fall Time vs. Temp.**

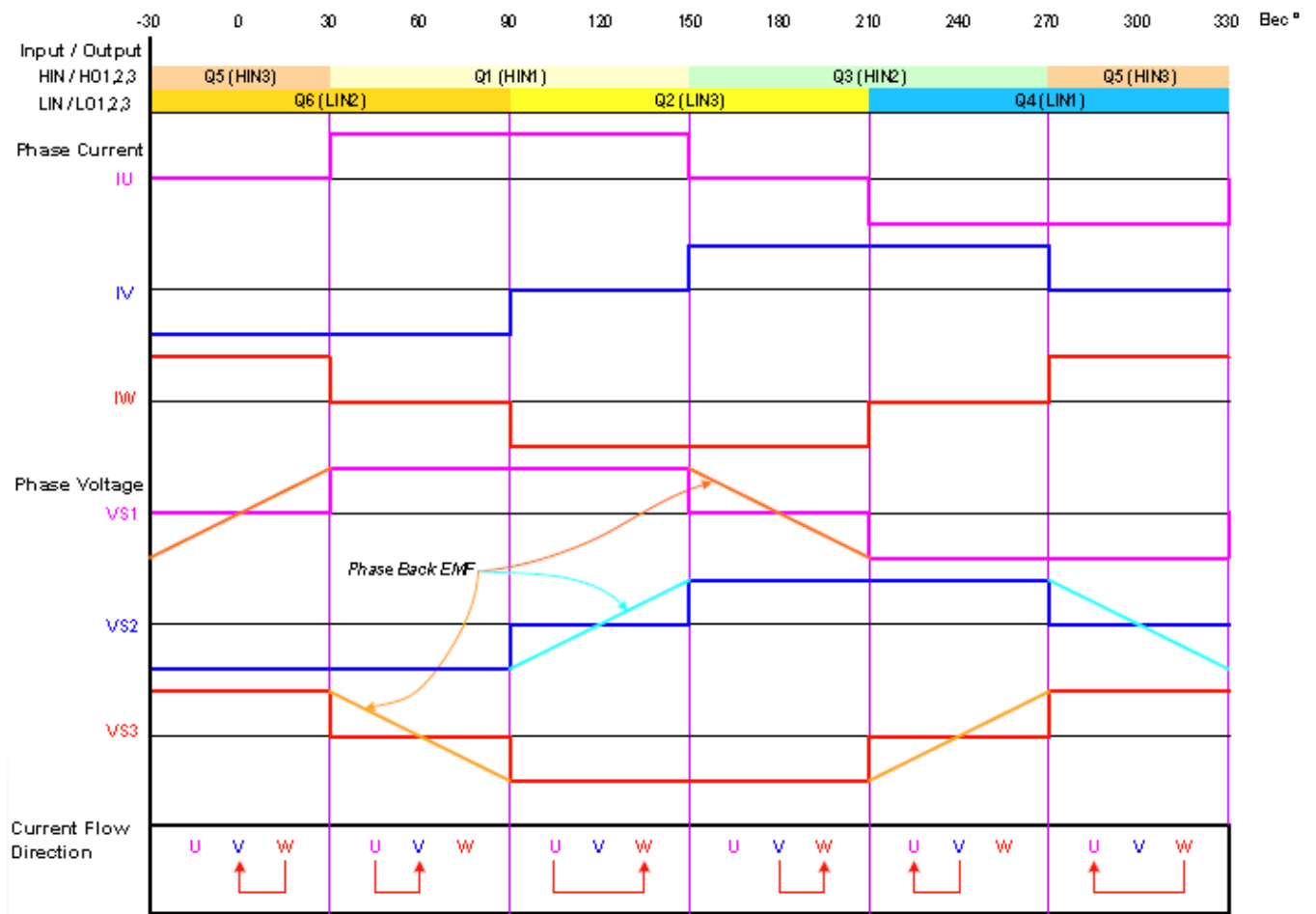
**Figure 8 Turn-on Delay Matching vs. Temp.**

**Figure 9 Turn-off Delay Matching vs. Temp.**

**Figure 10 Dead Time vs. Temp.**

**Figure 11 Dead Time Matching vs. Temp.**

**Figure 12 Quiescent V<sub>DD</sub> Supply Current vs. Temp.**

**Figure 13 Quiescent V<sub>BS</sub> Supply Current vs. Temp.**

**Figure 14 Operating V<sub>DD</sub> Supply Current vs. Temp.**

**Figure 15 Operating V<sub>BS</sub> Supply Current vs. Temp.**

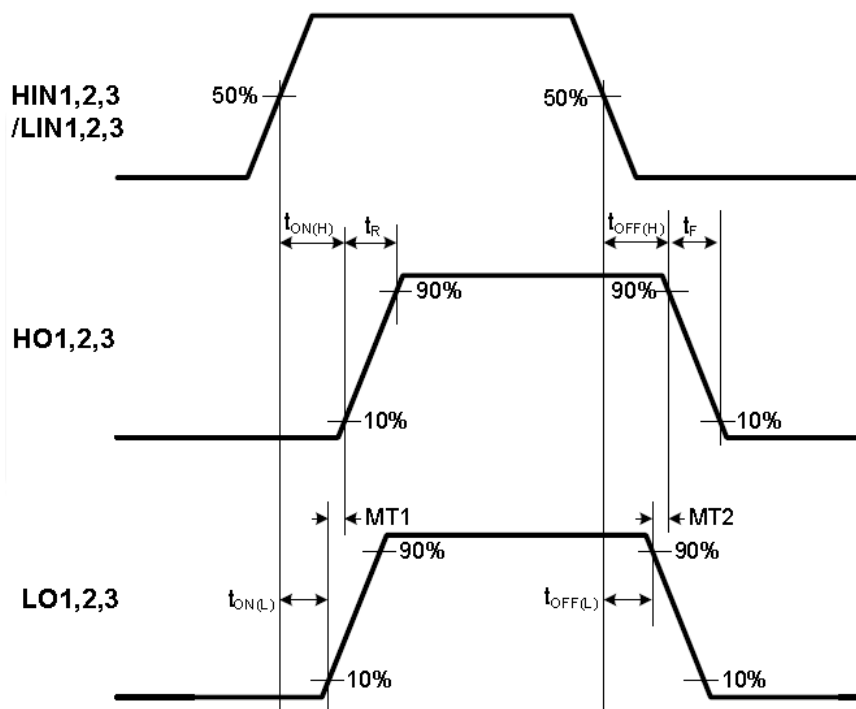

**Figure 16 V<sub>DD</sub> UVLO+ vs. Temp.**

**Figure 17 V<sub>DD</sub> UVLO- vs. Temp.**

**Figure 18 V<sub>BS</sub> UVLO+ vs. Temp.**

**Figure 19 V<sub>BS</sub> UVLO- vs. Temp.**

**Figure 20 High-level Output Voltage vs. Temp.**

**Figure 21 Low-level Output Voltage vs. Temp.**



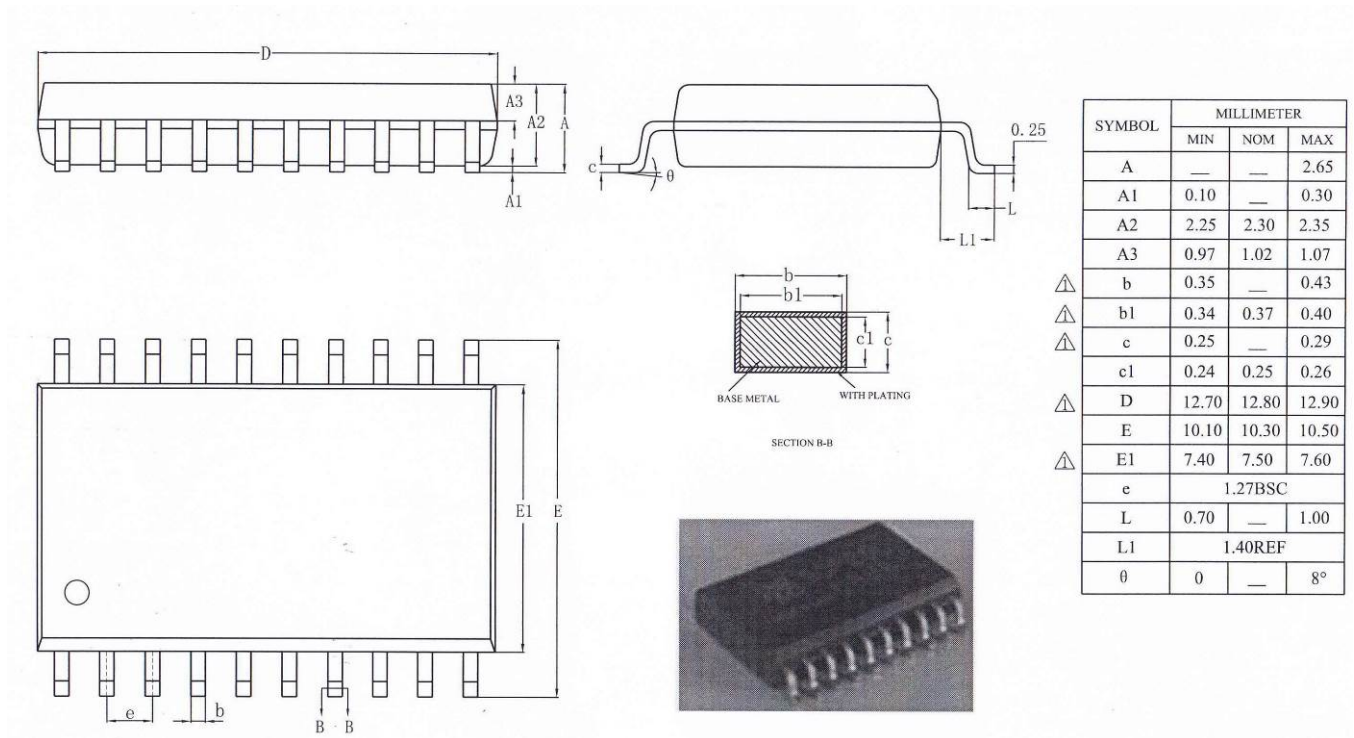

**Figure 22 Logic High Input Voltage vs. Temp.**

**Figure 23 Logic High Input Voltage vs. Temp.**

**Figure 24 Logic High Input Bias Current vs. Temp**

**Figure 25 Allowable Negative V<sub>S</sub> Voltage vs. Temp.**

**Figure 26 Input Pull-down Resistance vs. Temp.**

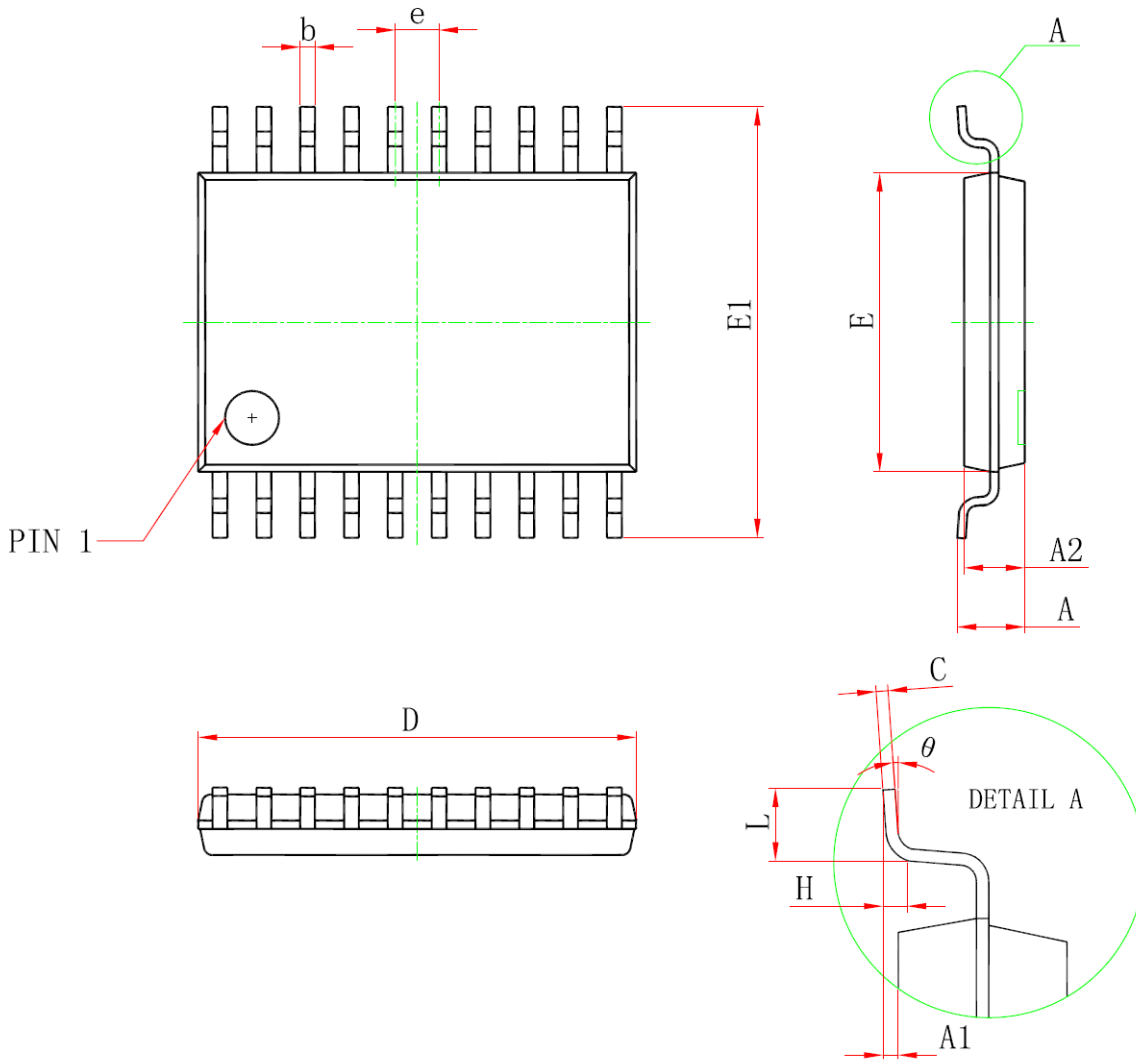

**Figure 27 120° Commutation Operation Waveforms for 3-Phase BLDC Motor Application**



**Figure 28 Switching Time Definition**

**PACKAGE CASE OUTLINE**
**SOIC-20L (WB)**

**TSSOP-20L (NB)**

Symbol	Dimensions In Millimeters		Dimensions In Inches	
	Min	Max	Min	Max
D	6.400	6.600	0.252	0.259
E	4.300	4.500	0.169	0.177
b	0.190	0.300	0.007	0.012
c	0.090	0.200	0.004	0.008
E1	6.250	6.550	0.246	0.258
A		1.200		0.047
A2	0.800	1.000	0.031	0.039
A1	0.050	0.150	0.002	0.006
e	0.65 (BSC)		0.026 (BSC)	
L	0.500	0.700	0.020	0.028
H	0.25(TYP)		0.01(TYP)	
$\theta$	1°	7°	1°	7°

## Revision History

Note: page numbers for previous revisions may differ from page numbers in current version

<b>Page or Item</b>	<b>Subjects (major changes since previous revision)</b>
<b>Rev 1.7 datasheet, 2019-8-27</b>	
Whole document	New company logo released
Page 1	Remove "June 2019"
<b>Rev 1.8 datasheet, 2019-12-19</b>	
Page 2	Change order information for SLM7888MD